

# Variwrap Controller Manual

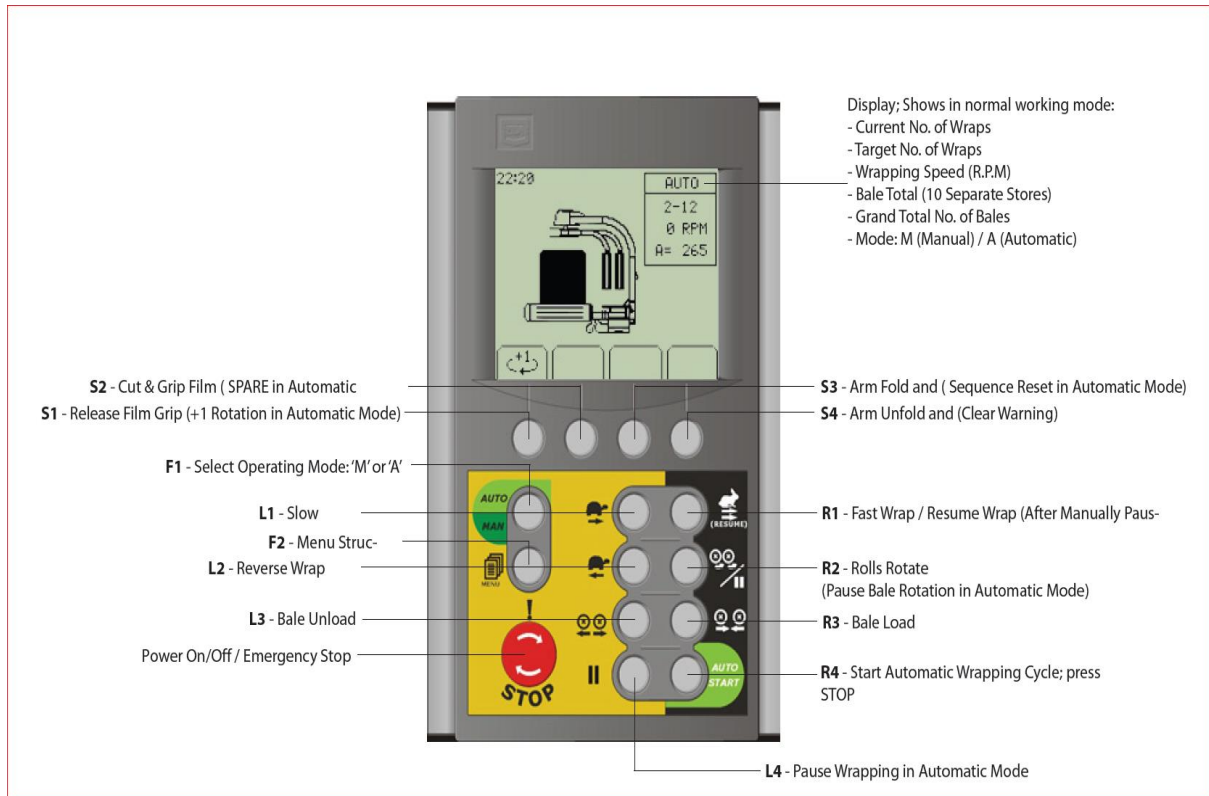

## Operation

The controller has two operating modes Manual and Auto. The mode is changes by pressing the (F1) Auto/Manual button. The mode setting is displayed in the top right corner Manual or Auto. The controller is usually operated in Auto mode where at one push of a button the machine will run through complete loading, wrapping and unloading sequences. Some manual function (by pressing individual buttons) are possible in Auto mode. In Manual mode all function are activated by pressing individual buttons on the controller.

## **Operation in Auto mode.**

Auto Start (R4) button activates the automatic wrapping cycle.

The wrap arms will unfold the wrapping position.

The wrapping arms will start rotating at slow speed and accelerate to full speed.

The Cut and Start will pop open and close to release the film.

On the last revolution the wrap arms will slow in the speed, they will fold together and the cut and start will open fully.

The wrapping arms come to a stop. The distance the wrapping arm passes the cut and start can be altered in the Operator setup by changing the time setting of Delay to Stop, increasing this time will get the arm to move further.

The cut and start closes to cut the film.

The wrap arm reverse to the parking position

## **Manually interrupting an Auto Cycle**

Pressing the red Emergency Stop button will cut the power to the controller and bring the machine to an immediate stop. This is recommended only for emergency use only as it puts high stress on the wrapping arms if they are brought to a sudden stop from full speed.

Pressing (L4) button will bring the machine to a controlled stop.

Pressing (R1) button will get the controller to resume the interrupted cycle from where it stopped.

## **Loading and Unloading**

Pressing (R3) button will move the roller arms inwards for loading a bale. There is a setting ROLLERS IN in the Operator Setup on the controller which sets a time for loading. When this is set to 0.0 (seconds) then the button must be kept pressed for

loading. If a time is set here eg. 5.0s, then then one touch of the (R3) button will get the arms to move in for that time.

Pressing (L3) button will move the rollers outwards for unloading. As with loading ROLLERS OUT will set a time for automatic unloading.

### Auto Wrap

When automatic loading is complete it is possible to set the controller to automatically start wrapping without having to push the (R4) AUTOSTART button. To do this go to Operator Setup on the controller and set Auto wrap: to ON. If the controller is power down and switched back on it will ask to confirm that Auto Wrap is still required. Pressing the (L3) arrow button will confirm this.

### Controller Screen

The controller has two operating modes Manual and Auto, this had been explained in the preceding section. When the controller is powered up by rotating the red emergency stop button it is in manual mode and the display below is on the screen. In manual mode the buttons for opening and closing the cutter and folding and unfolding the arm are available, see below. Pushing the (F1) Auto/Manual button changes the controller to Auto mode and the display changes. When the machine is being operating in Auto the function active at the time is displayed graphically on the screen.

### Main Screen: MANUAL

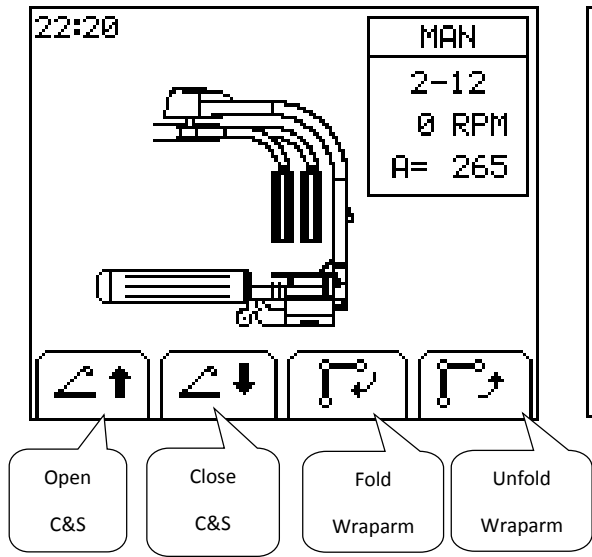

### Main Screen: AUTO

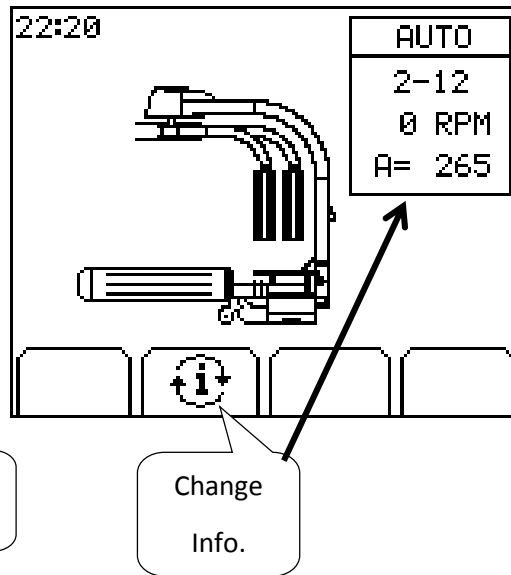

The box on the top right hand side of the screen can display additional operating and diagnostic information. It has three different displays. Pressing the (S2) (i) button changes the information displayed in this box, see below.

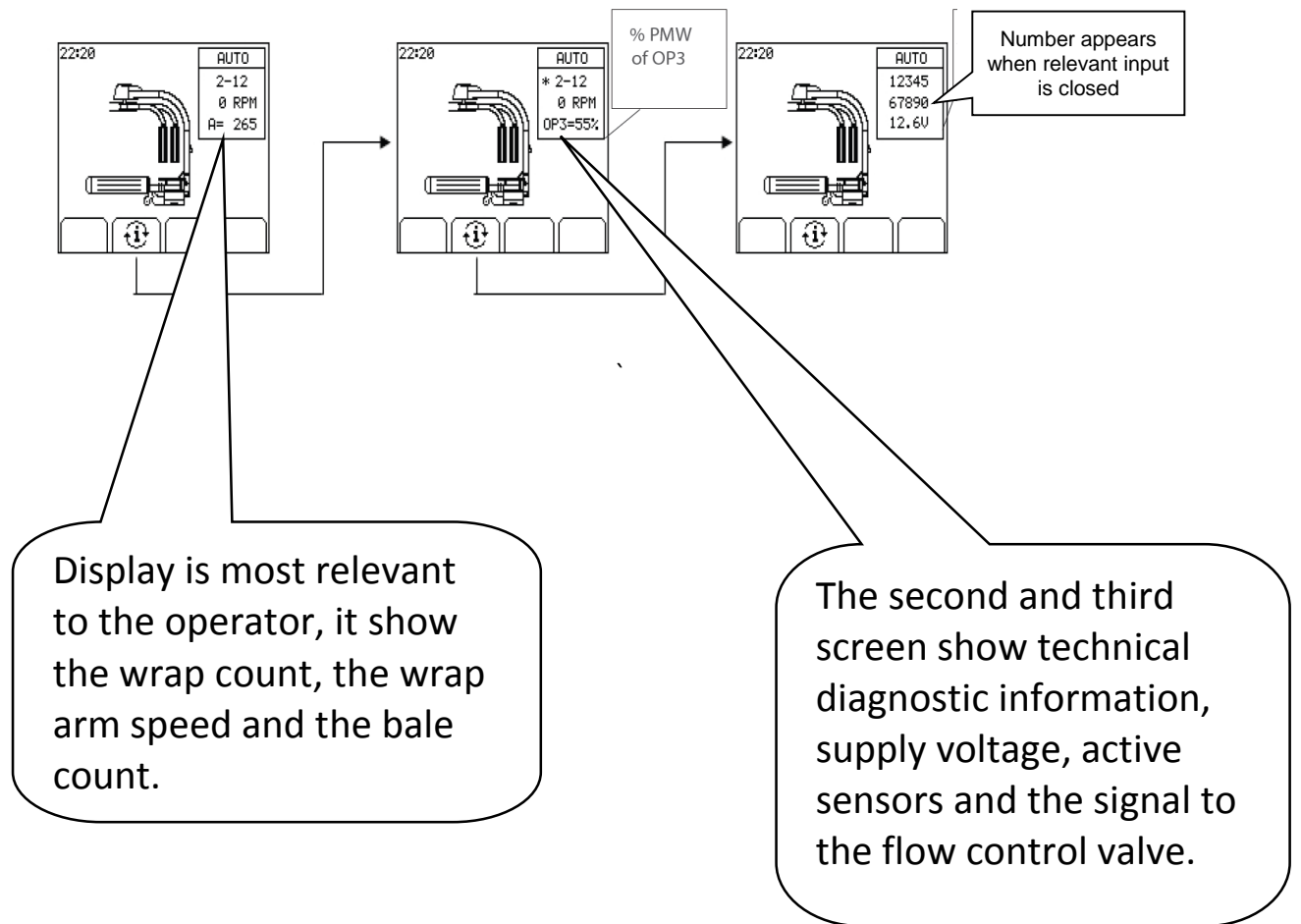

## Machine Menu

Changes can be made to the some of the operating parameters on the Variwrap controller in the Machine Menu. This is accessed by pressing the (F2) Menu button.

There are three sub menus in the Machine Menu:

Operators Setup

Bale Count

Technician Setup



## Operator setup.

The operator setup has parameters commonly requiring change by the operator. The arrows button moves the indicator from one parameter to the next, the + and – buttons make changes to the setting. ESC exits the setup when the change is made. There are 2 pages to the setup.



## Explanation of these parameters.

Parameter	Default	Description
Target Wraps	18	This sets the number of film wraps to be applied to the bale. Note: that the controller counts in steps of 2 or 3 depending on the number of wrapping arms.
Bale Total	A	This selects the counter to be used to count the wrapped bales. The number of bales in the counter is displayed in the top level display.
Film Break	Off	This switches On or Off film break sensors.
Auto Load	Off	If the optional Auto Load sensor is fitted on the machine this parameter enables or disables this sensor. When it is set to off the (R3) must be pressed to start loading.
Auto Wrap	Off	When loading has finished it is possible to automatically start wrapping without having to press the (R4) Autostart button. Setting this parameter to On enables auto starting.
Roller In	5.0s	This sets the time duration for one touch loading. When this parameter is set to 0.0 the (R3) button must be kept pressed for loading.
Rollers Out	5.0s	This sets the time duration for one touch unloading.
Page 2/2		
Delay to Stop	1.0	This set the time duration the wrapping arms move past the opened film cutter at the end of wrapping. Increasing this time will get the arms to move further.
Rotation After	0.0	It is possible to get the wrapped bale to rotate on the rollers when wrapping has finished. This can be used to place the loose ends of the film under the bale when it is unloaded (to prevent the film from unravelling from the bale)

## Bale Count Menu

The bale count menu shows the count in all 10 counters in one screen. Selecting an individual counter using the arrows button and pressing the RESET button will reset that counter to 0.

The total bale count on the machine is also show here in Grand Total. This cannot be reset

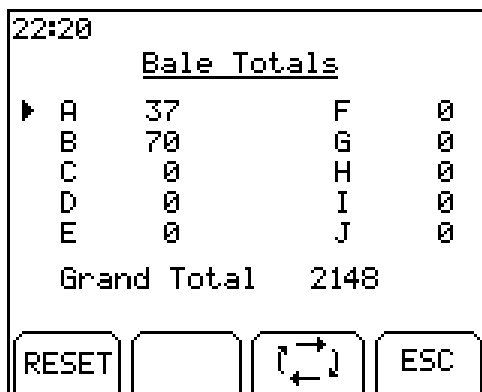

## Technician Setup

The parameters in the Technician Setup should only be changed by an experienced technician. It is protected with a pin code, 1,2,3,4

The Technician setup has 8 sub menus:



## Load Setup

The Load Setup contains parameters related to loading and unloading.

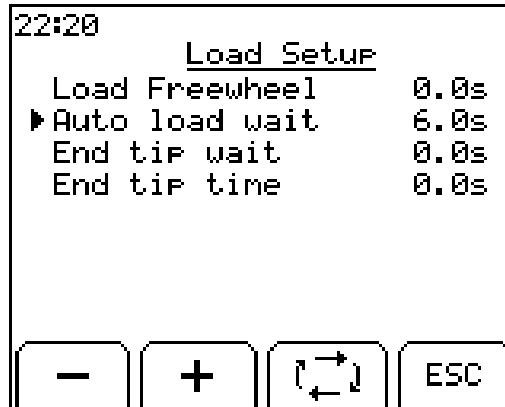

Function	Default	Description
Load freewheel	0.1s	Time at the beginning of loading that the gripped roller rotates with limited force on the loading arm. Used on L model to start the bale rolling in for loading
Auto load wait	6.0s	Time delay from (optional) autoloader sensor detecting bale to auto loading starting. The optional Autoloader sensor will trigger loading to start without the operator pushing a button.
End tip wait	0.0s	Time delay from bale offloading to end tip retracting. End tip time must also be set.
End tip time	0.0s	Time end tip retracts before next bale starts to load. If this is set to 0.0 then the end tip will not retract until the next bale starts to load.



## Cut and Start Setup

The C&S Setup contains parameters related to the operation of the film Cut and Start.

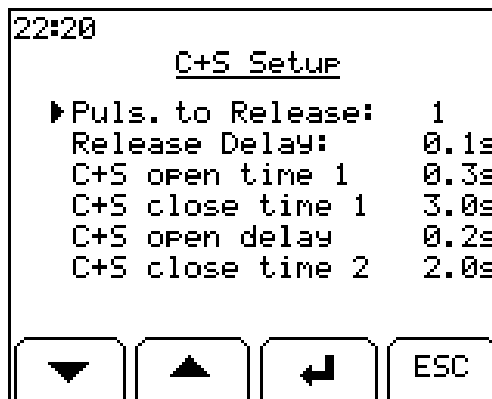

Function	Default	Description
Puls. To Release	1	Number of revolutions of the wrapping arm before the Cut and Start pops open to release the film.
Release Delay	0.1	Delay to Cut and Start popping open on to release film on second revolution of the wrapping arm.
C+S open time 1	0.3s	Time the Cut and Start pops open to release the gripped film.
C+S close time 1	3.0s	Time the Cut and Start snaps closed after releasing the gripped film.
C+S open delay	0.1s	Time delay to Cut and Start opening on the last revolution of the wrapping arm.
C+S close time 1	2.0	Time for Cut and Start to close to cut the film when wrapping is finished.

## Wrap Setup

The Wrap Setup contains parameter related to the wrapping process.

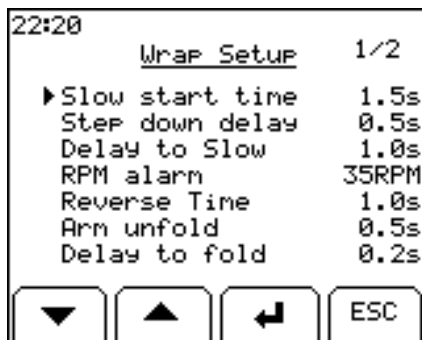

Parameter	Default	Description
Slow start time	1.5s	Time that the wrapping arm moves in slow speed at the beginning of the automatic wrapping cycle
Step down delay	0.5s	It is possible to automatically reduce the speed of the wrapping arm during the second last revolution of the wrapping cycle to give more time for folding the arm and opening the cut and start. The reduction in speed is set in the Speed Setup. This Step down delay is the time from the beginning of the second last revolution to when the speed reduces.
Delay to Slow	1.0s	This is the time delay from the beginning of the last revolution of the wrapping cycle to when the wrapping arm changes from fast to slow speed.
RPM Alarm	35 RPM	This sets the wrapping arm speed that triggers the over speed alarm.
Reverse Time	1.0s	This is the time the wrapping arm reverses at the end of wrapping (If Park Posn Check is set to No, see below)
Arm unfold	0.5s	There is a sensor on the folding wrapping arm that tells the controller that it has unfolded to the wrapping position. This Arm unfold sets the time the wrapping arm continues to unfold when it reaches the sensor.
Delay to fold	0.2s	This is the time delay from the beginning of the last revolution of wrapping to when the wrapping arm starts to fold.
Page 2/2		
Park Posn Check	No	When this is set to Yes, the wrapping arm reverses to a definite park position at a sensor. The machine will not load or unload if the arm is not parked in this position. When this is set to No the wrapping arm reverses for Reverse time.
Reverse +	0.0s	This sets the additional time the wrapping arm reverses when it reaches the park position. This helps get the wrapping arm to park centrally in the park position
Slow Freewheel	Off	When set to On, the bale rollers will stop turning when the wrapping arms are in slow speed

## Speed Setup

The Speed Setup menu is used change the proportional valve flow settings for the various function on the machine. It sets the percentage opening of the valve.

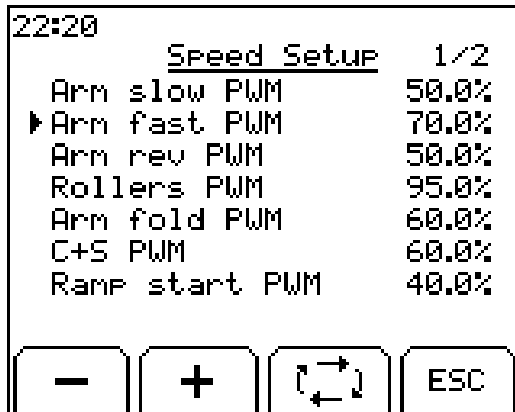

Function	Default	Description
Arm slow PWM	50%	Sets the slow wrapping arm speed at the beginning and end of the wrapping cycle
Arm fast PWM	70%	Sets the fast wrapping arm speed.
Arm rev PWM	50%	Sets the wrapping arm speed in the reverse direction.
Rollers PWM	95%	Sets the speed of the roller arms for loading and unloading the bale
Arm fold PWM	60%	Sets the speed of unfolding the wrapping arms.
C+S PWM	60%	Sets the speed of the film cutter opening and closing
Ramp start PWM	60%	This is the minimum setting of the proportional valve, it should be set at 40% on this machine.
Page 2		
Step down PWM	5.0%	It is possible to reduce the arm speed on the second last revolution of the wrapping cycle to go give more time for folding and opening the cutter. This sets the speed reduction.
Arm ramp up	1.0s	Sets the time for the wrapping arm to accelerate from slow to fast speed.
Arm ramp down	0.8s	Sets the time the wrapping arm to decelerate from fast to slow speed

## Instrument Setup

The Instrument Setup set parameter of the controller itself. The contrast and brightness of the display, the volume of the warning buzzer and the button bleeper. The time and language are also set here.

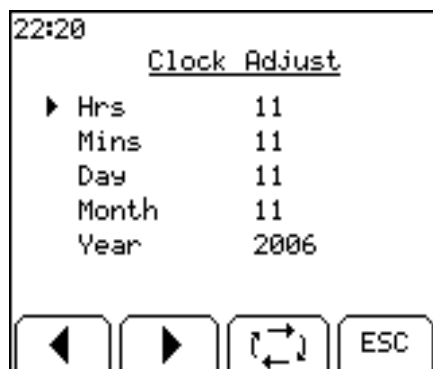
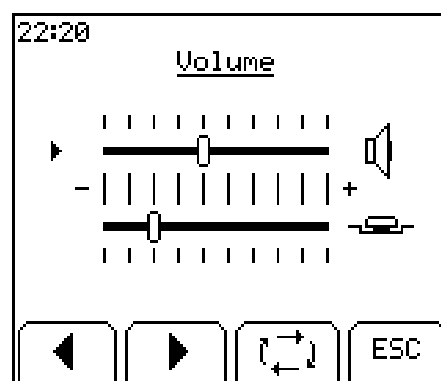
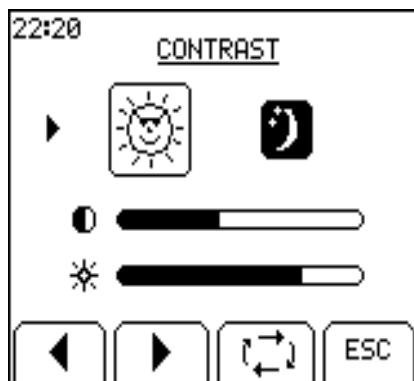

## Film Break Setup

The film break sensing can be set On or Off in the Operator Setup.

The Film Break Setup set the technical parameters related the film break when it is set On. The rollers are pulsed on and off to reduce their speed if one (or two on the 3 wrapping arm models) have broken. The time periods the rollers are rotating and stopped are set here. The controller also automatically changes the counting of the rotations of wrapping arm in steps of one rather than in steps of two or three because only one film is being applied per revolution.

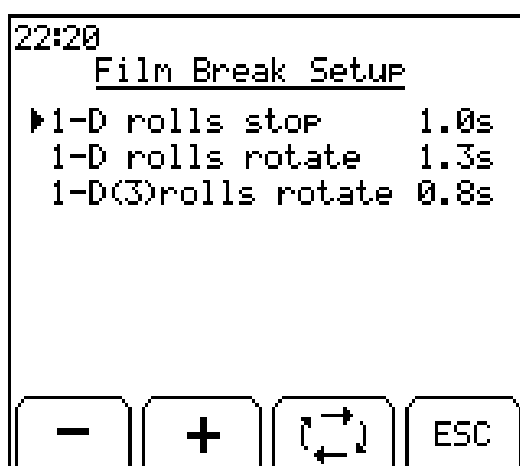

Function	Default	Description
1-D rolls stop	1.0s	Sets the time period the rollers stop when a film break is detected
1-D rolls rotate	1.3s	Sets the time period the rollers rotate on a 2 wrapping arm machine when a film break is detected.
1-D(3) rolls rotate	0.8s	Sets the time period the rollers rotate on a 3 wrapping arm machine when a film break is detected.

## Model Setup

The Model Setup sets the parameters for the number of wrapping arms and the type of loading arm.

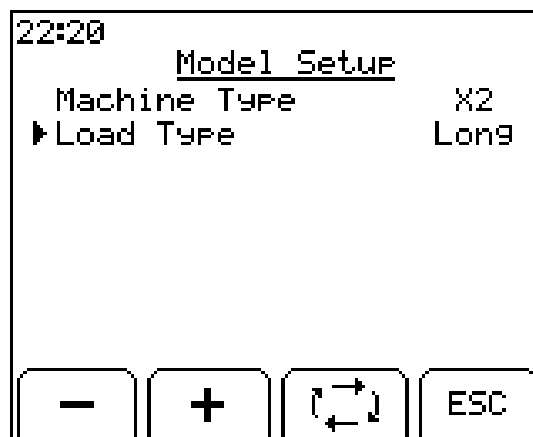

Function	Default	Description
Machine Type	X2	Sets the number of wrapping arms. X2 for 2 wrapping arms, X3 for 3 wrapping arms.
Load Type	Long	Sets the type of loading arm (s) Long or Short

## Reset Defaults

This will reset all the controller setting back to the original default settings. The controller may have many altered setting to suit different situations so resetting should only be carried out as a last resort as there may be a lot of adjusting of settings afterwards.

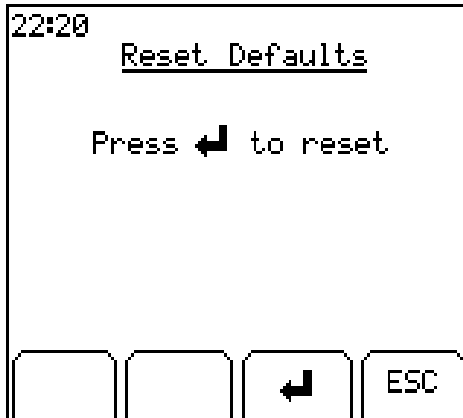

## Warning Displays

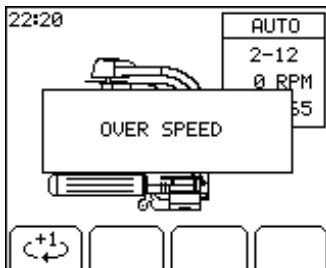

### OVER SPEED

Warning appears if wrapper RPM exceeds 'RPM Alarm' setting. RPM alarm is set in Technician/Wrap Setup. Default setting 35RPM

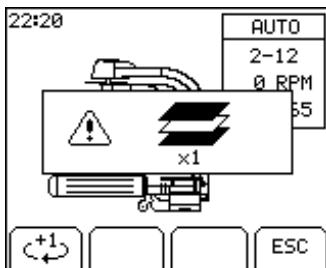

### FILM BREAK

If the software detects that only 1-dispenser is applying film this warning will appear. Pressing S4 will cancel the warning but the wrapping sequence will continue in 1-dispenser mode.

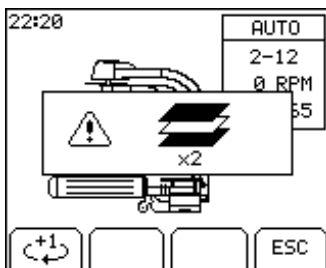

### FILM BREAK

This warning appears if the software detects that both film dispensers have broken. The wrapper comes to a controlled stop. Pressing S4 cancels the warning but the wrapper should still come to a controlled stop.

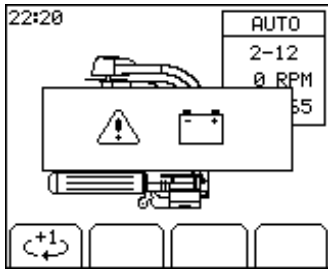

**LOW VOLTAGE**

Warning appears if the supply voltage is low, below 10.5V.

**RESET SAFETY**

Warning appears if safety arms trips during wrapping. Outputs switch off and wrapping stops.

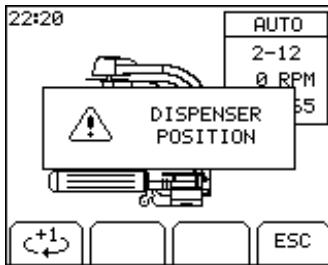
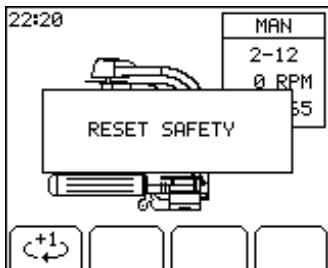

**DISPENSER POSITON**

Warning appears if 'Park Posn. Check' is set to Yes, and arm is not in park position when L3 is pressed to unload a bale or R3 is to load the bale.



